

 **bonprix.** Artikel Nr. 910260

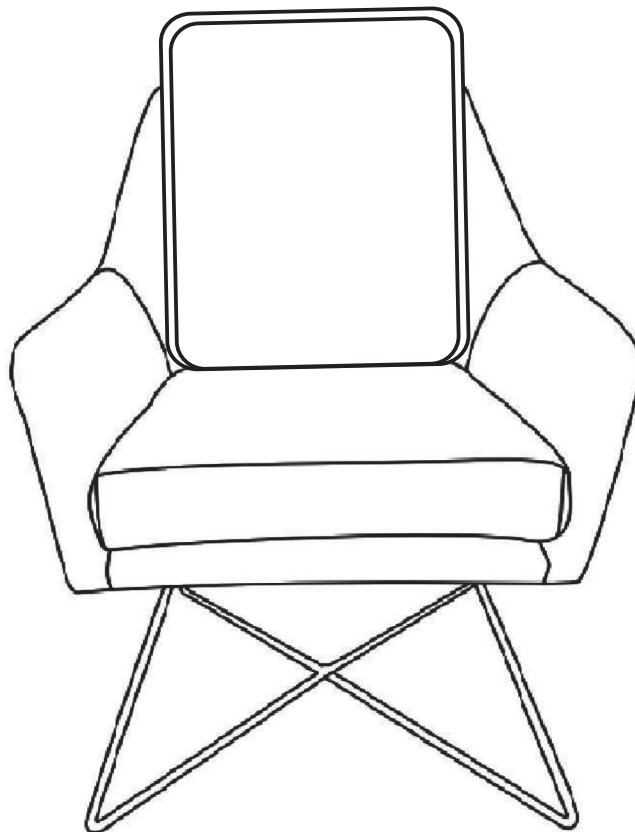

15-m



ax5 (+1) pcs

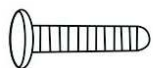

bx1 pcs

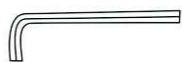

Ⓐ x1

Ⓑ x1

Ⓒ x1

Ⓐ

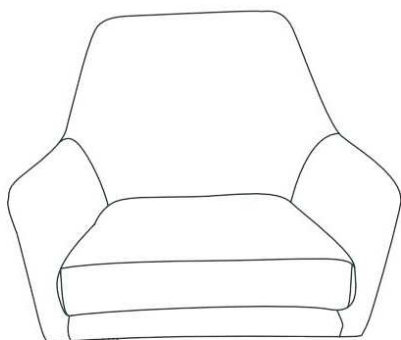

Ⓑ

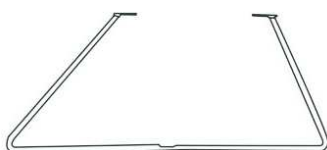

Ⓒ



Schritt 1

NR.	Menge
a	1
b	1

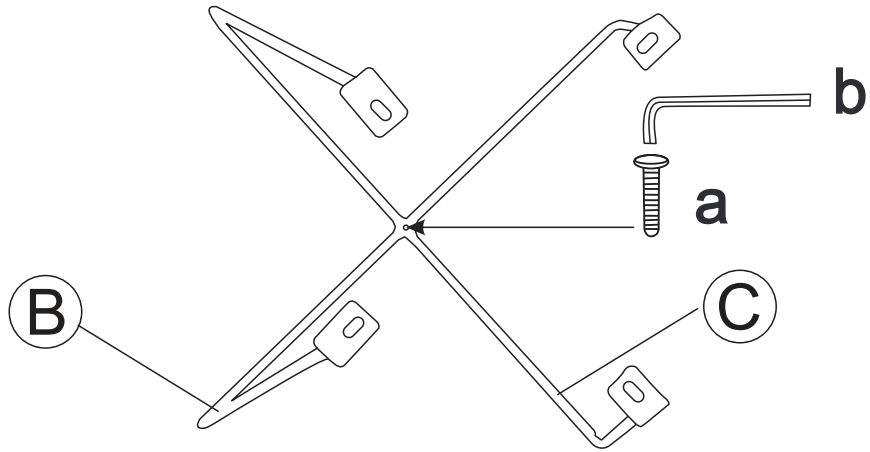

Schritt 2

NR.	Menge
a	4
b	1

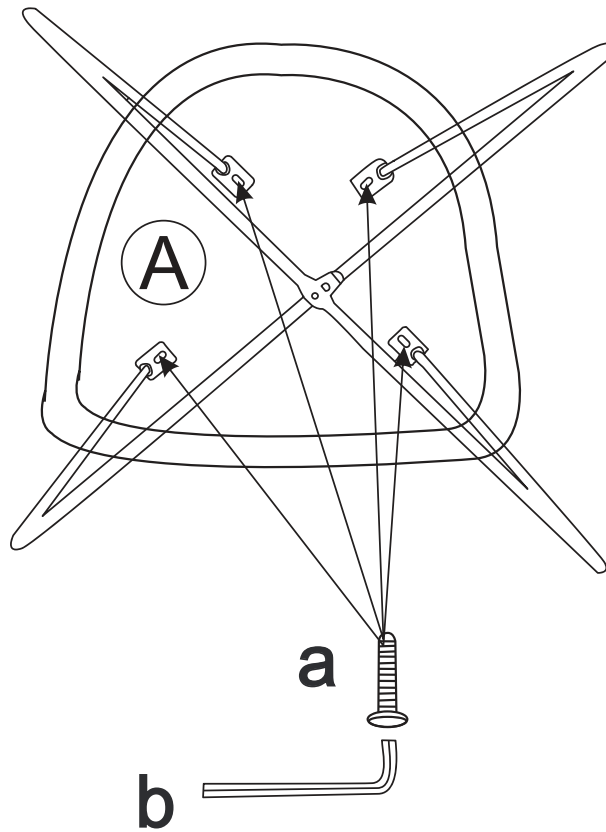

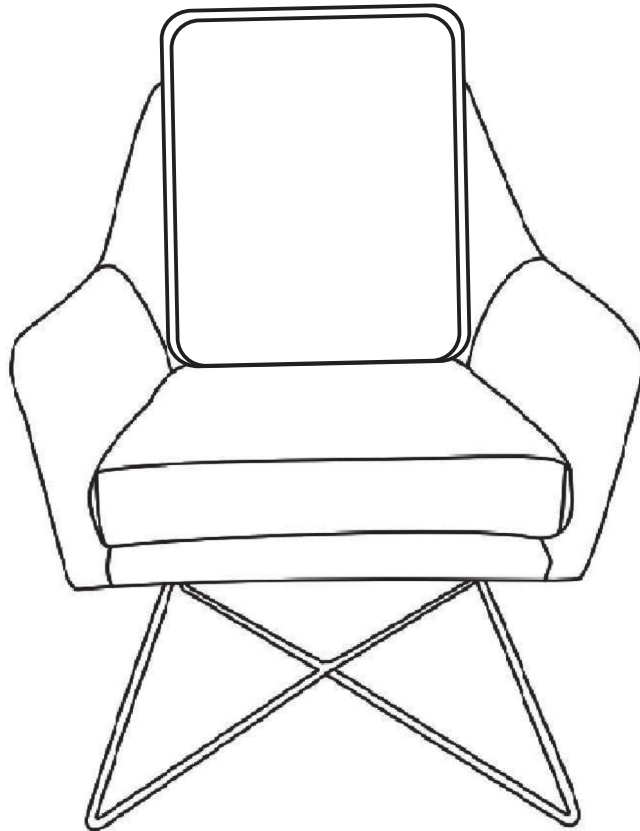

MAX LOADING:110KGS